

Aventa In-line Mixed Flow Fan

230V Fan Installation and Operating Guide



Aventa AV100B - 9041085
Aventa AV100T - 9041086

Aventa AV125B - 9041087
Aventa AV125T - 9041088

Aventa AV150B - 9041089
Aventa AV150T - 9041090



Aventa Fan Dimensions

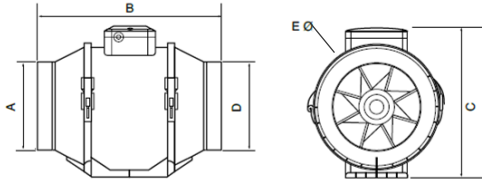

Model	A	B	C	E
AV100	96	246	190	167
AV125	123	246	190	167
AV150	146	295	250	223

Fan Specification

Type	Air flow, m³/h	Current, Amps	Power, Watts	Noise level, db(A) @ 3m
AV 100/T	145/187	0.11/0.21	21/33	27/36
AV 125/T	220/280	0.18/0.27	23/37	28/37
AV 150/T	405/520	0.17/0.27	30/60	33/34

Range overview

Aventa In-line Mixed Flow fans are available in 3 model sizes with or without timer function and have 2 speeds.

Aventa In-line Mixed Flow fans can be used as a simple extract or supply fan where high pressure and flow rates are required. They can be mounted vertically with a condensation trap fitted or horizontally. The range has been designed to accept standard ducting sizes. The main body of the fan (1) is detachable from the inlet and outlet spigots and mounting assembly via the 2 clamps

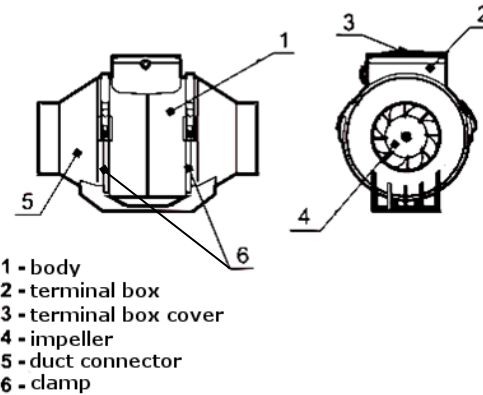

Electrical installation

The Aventa In-line Mixed Flow range is IPX4 rated and is suitable for mounting in Zone 2 in bathrooms, toilets, kitchens, utility rooms when installed with a 30mA RCD. The fan requires a 230V 50Hz single phase supply. Class II equipment. BS EN 60417. An external 3A fuse is required for each fan unit. Cable sizes (max): Fixed flat wiring 2 core 1mm², 3 core 1/1.5mm². All electrical installation to be carried out by an approved electrician in accordance with Part "P" U.K. Building Regulations and to the latest IEE standards, or the appropriate regulations in the country of installation.

Important

The Aventa In-line Mixed Flow fan range is IPX4 rated and complies with the requirements of the EU norms and directives. Do not place the fan unit near direct heat sources, e.g. radiant heaters, or where temperatures can exceed 40°C (104°F). Precautions must be taken to avoid back flow of gases in rooms with open flue fuel burning appliances.

Electrical installation

AV100B , AV125B

Min Speed Wiring

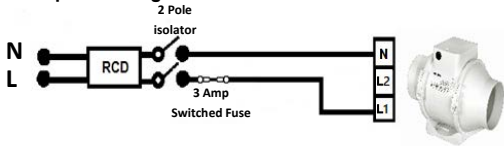

Max Speed Wiring

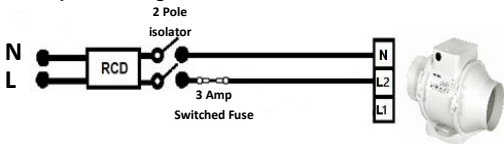

Min/Max Speed Wiring

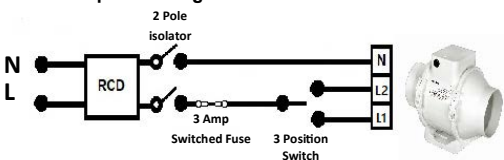

NOTE: Aventa AV150B wiring on page 9.

Electrical installation

AV100T , AV125T, AV150T

Min Speed Wiring

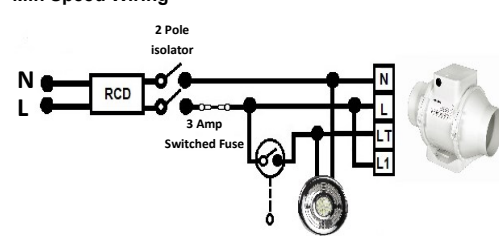

Max Speed Wiring

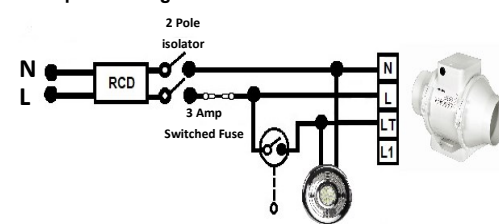

Terminal Blocks Guide

Basic Terminal

N Neutral
L2 Live High Speed
L1 Live Low Speed

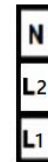

Timer Terminal

N Neutral
L Permanent Live
LT Switch Live Trigger
L1 Live Link Low Speed

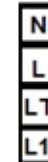

Mechanical installation

Determine the orientation of the fan airflow direction by the use of the flow direction arrow on the fan body (1). (See diagram on page 3).

Remove the fan body by releasing the 2 clamps (6). Using the mounting base as a guide mark and drill 4 holes. Use the wall plugs and screws provided and secure the mounting base to the mounting surface. Insert the fan body (1) and secure with the retaining clamps (6). (See diagram on page 3).

Connect the appropriately sized ducting to the spigot ducts. Airflow Developments Ltd recommends that rigid ducting is used instead of flexible ducting, this will help to ensure maximum performance.

Fan Timer Adjustment

The fan with timer function switches on when the voltage is supplied to the LT terminal via an external switch.

After the voltage to the LT terminal is disconnected the fan continues to run for the set Run on timer period, between 1 and 20 minutes. The Run on timer is factory set to 15 mins, it is adjusted by turning the potentiometer (T) clockwise to increase and anti-clockwise to decrease.

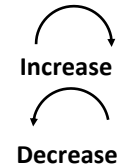
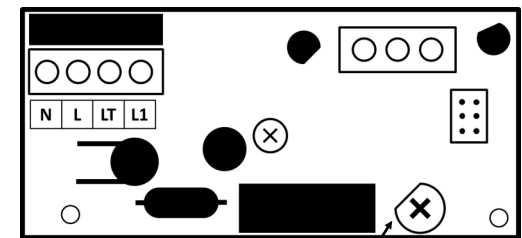

Electrical installation

AV150B

Min Speed Wiring

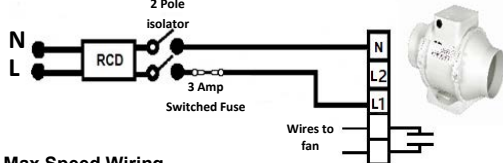

Max Speed Wiring

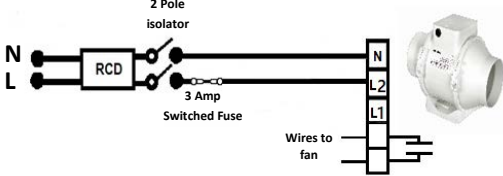

Min/Max Speed Wiring

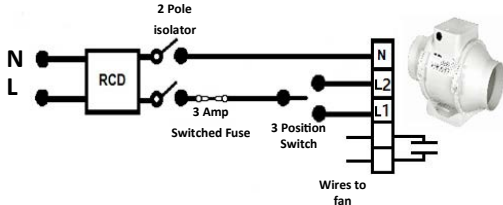

Page 9 of 16

Installation with flexible ducting

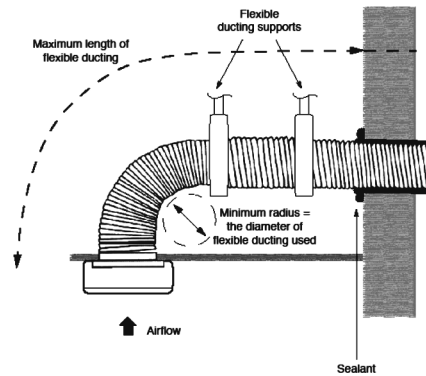

Where flexible ducting is used the diameter must be maintained with the minimum radius of a bend equal to the diameter of the ducting. It is good ventilation practice that the ducting is extended to 90% of its possible length in order to maintain the best possible airflow. Ensure that flexible duct connections are not over tightened to the fan outlet spigot. To maximise airflow rigid ducting should be used where possible. The fan and ducting should be installed in accordance with the requirements of the Domestic Ventilation Compliance Guide, part of the Building Regulations.

Page 10 of 16

Recommended Best Practice

The Building Regulations 2010, Statutory Instrument Part 9, paragraph 42, imposes a requirement that testing and reporting of mechanical ventilation performance is conducted in accordance with an approved procedure. Compliance with this requirement by an assessed and registered 'Competent Person' should follow a 'Best Practice' process and adopt air flow measurement, Method A – The Unconditional Method – using a suitable UKAS certified measuring instrument. Generically referred to as a 'Zero Pressure Air Flow Meter' or 'Powered Flow Meter'. Further information on this method is detailed in NHBC Building Regulations Guidance Note G272a 10/13 and BSRIA 'A Guide to Measuring air flow rates' document BG46/2015

Page 11 of 16

Maintenance

SAFETY FIRST: ALWAYS ISOLATE THE FAN UNIT FROM THE POWER SUPPLY BEFORE REMOVING THE COVER.

When installed according to these instructions the Aventa in-line range is completely safe. The materials used do not constitute a hazard.

Cleaning

The external housing of the fan can be wiped with a damp cloth. Do not use household cleaners containing abrasives.

Note: Always isolate the fan when cleaning. Never clean any parts of the fan assembly by immersing in water or using a dishwasher.

Warning

This appliance can be used by children aged from 8 years and above and persons with reduced physical, sensory or mental capabilities or lack of experience and knowledge if they have been given supervision or instruction concerning use of the appliance in a safe way and understand the hazards involved. Children shall not play with the appliance. Cleaning and user maintenance shall not be made by children without supervision.

Page 12 of 16

Warranty

Applicable to units installed and used in the United Kingdom. Airflow Developments Ltd guarantees the Aventa in-line for 3 YEARS from date of purchase against faulty material or workmanship. Warranty only covers the fan, not the reinstallation of this if required. In the event of any defective parts being found, Airflow Developments Ltd reserve the right to repair or at our discretion replace without charge provided that the unit:

1. Has been installed and used in accordance with the fitting and wiring instructions supplied with each unit.
2. Has not been connected to an unsuitable electrical supply.
3. Has not been subjected to misuse, neglect or damage.
4. Has not been modified or repaired by any person not authorised by Airflow Developments Ltd
5. Has been installed in accordance with latest Building Regulations and IEEE wiring regulations by a recognised competent installer.

Airflow Developments Ltd shall not be liable for any loss, injury or other consequential damage, in the event of a failure of the equipment or arising from, or in connection with, the equipment excepting only that nothing in this condition shall be construed as to exclude or restrict liability for negligence.

This warranty does not in any way affect any statutory or other consumer rights.

Page 13 of 16



Disposal

Do not dispose of with household waste. Please recycle where facilities exist. Check with your local authority for recycling advice.

UK Head-Office

AIRFLOW DEVELOPMENTS Limited
Adelle House, Lancaster Road
Cresser Business Park
High Wycombe
Buckinghamshire
HP12 3QP
United Kingdom

Tel: +44 (0) 1494 525252
Fax: +44 (0) 1494 461073
Email: info@airflow.com
Web: airflow.com

Czech Republic

AIRFLOW LUFTECHNIK GmbH
organizační složka Praha
Hornýská 520
108 00 Praha 10
Czech Republic

Tel: +42 (0) 2 7477 2230
Fax: +42 (0) 2 7477 2370
Email: info@airflow.cz
Web: airflow.cz

Germany

AIRFLOW LUFTECHNIK GmbH
Wolbersacker 16
53359 Rheinbach
Germany

Tel: +49 (0) 222 69205 0
Fax: +49 (0) 222 69205 11
Email: info@airflow.de
Web: airflow.de



AIRFLOW DEVELOPMENTS LTD reserve the right in the interest of continuous development to alter any or all specifications without prior notice.

80000434 Issue 4 09/24

Page 14 of 16

Page 15 of 16

Page 16 of 16